

SNO-WAY®

SNOW & ICE CONTROL EQUIPMENT

WIRING DIAGRAM AND INSTALLATION INSTRUCTIONS

**FOR 99101307
ADAPTER KIT**

Sno-Way®; Down Pressure® and EIS® are registered trademarks of Sno-Way International, Inc.
ProControl™, MegaBlade™, V-Wing™, E-Z Switch™, Revolution™, MaxAdjust™, SpeedLock™, and
QuickJack™ are trademarks of Sno-Way International, Inc.

©2017 Sno-Way® International

97102115A

WIRING DIAGRAM



1. THINK SAFETY, ALWAYS WEAR SAFETY GLASSES WHEN PERFORMING THE OPERATIONS PRESCRIBED IN THESE INSTRUCTIONS
2. READ ALL INSTRUCTIONS CAREFULLY BEFORE ATTEMPTING INSTALLATION

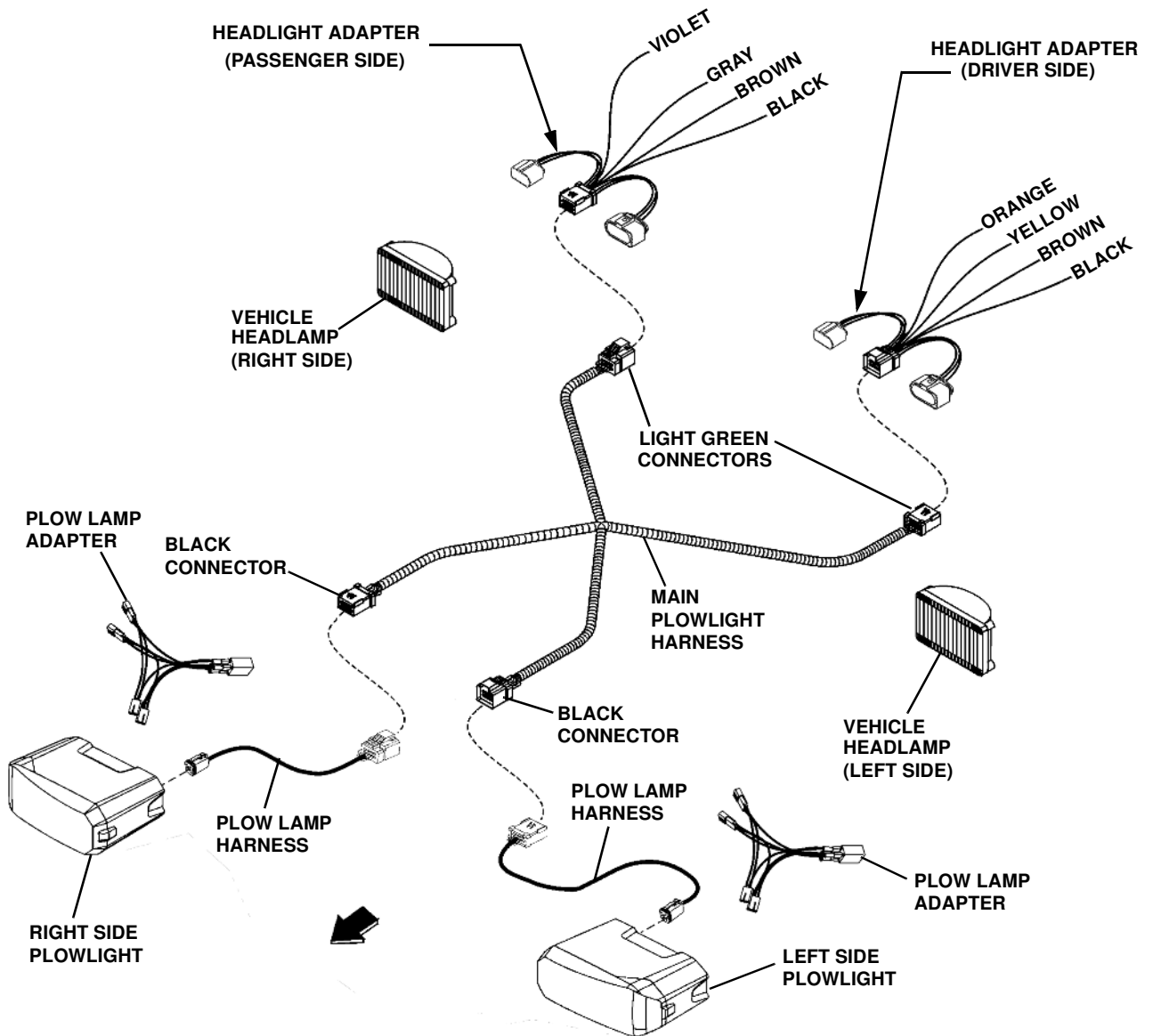

Headlight Adapter Schematic - Female (96116722) Driver Side

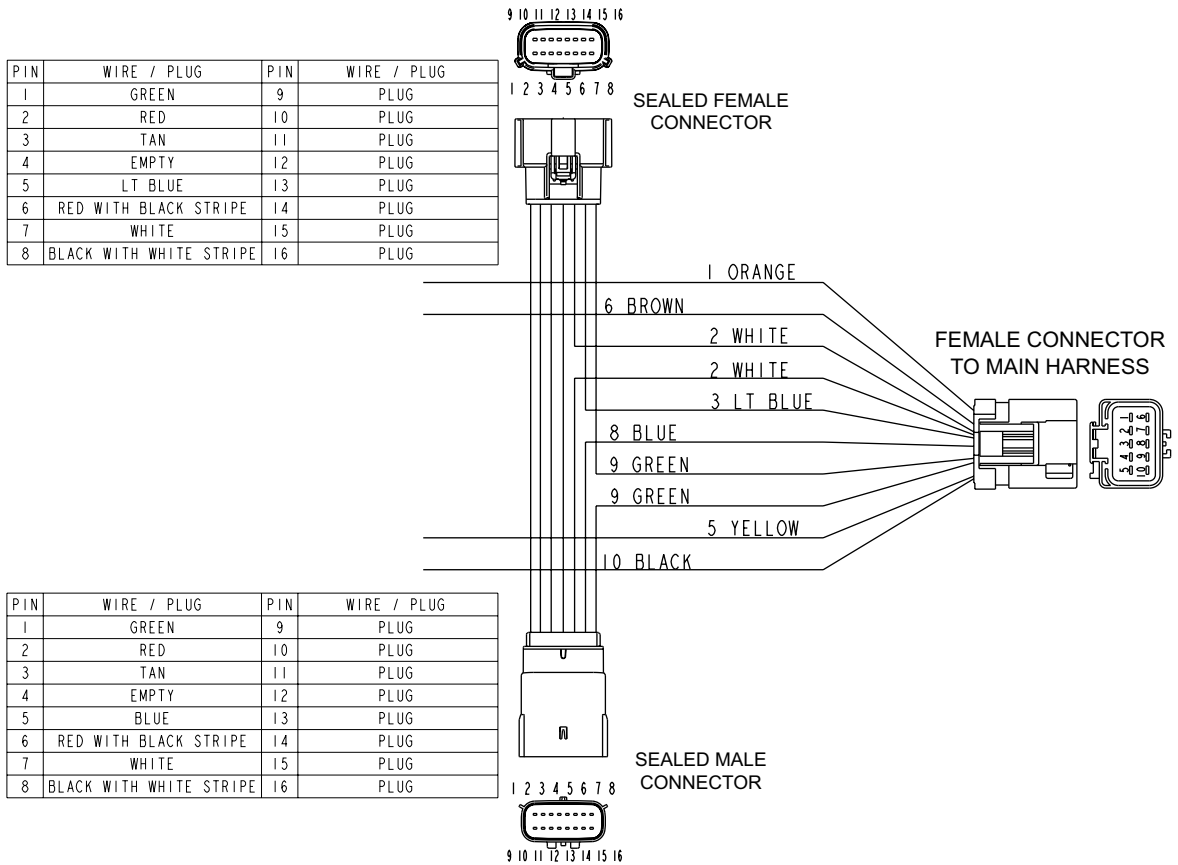

Headlight Adapter Schematic - Male (96116723) Passenger Side

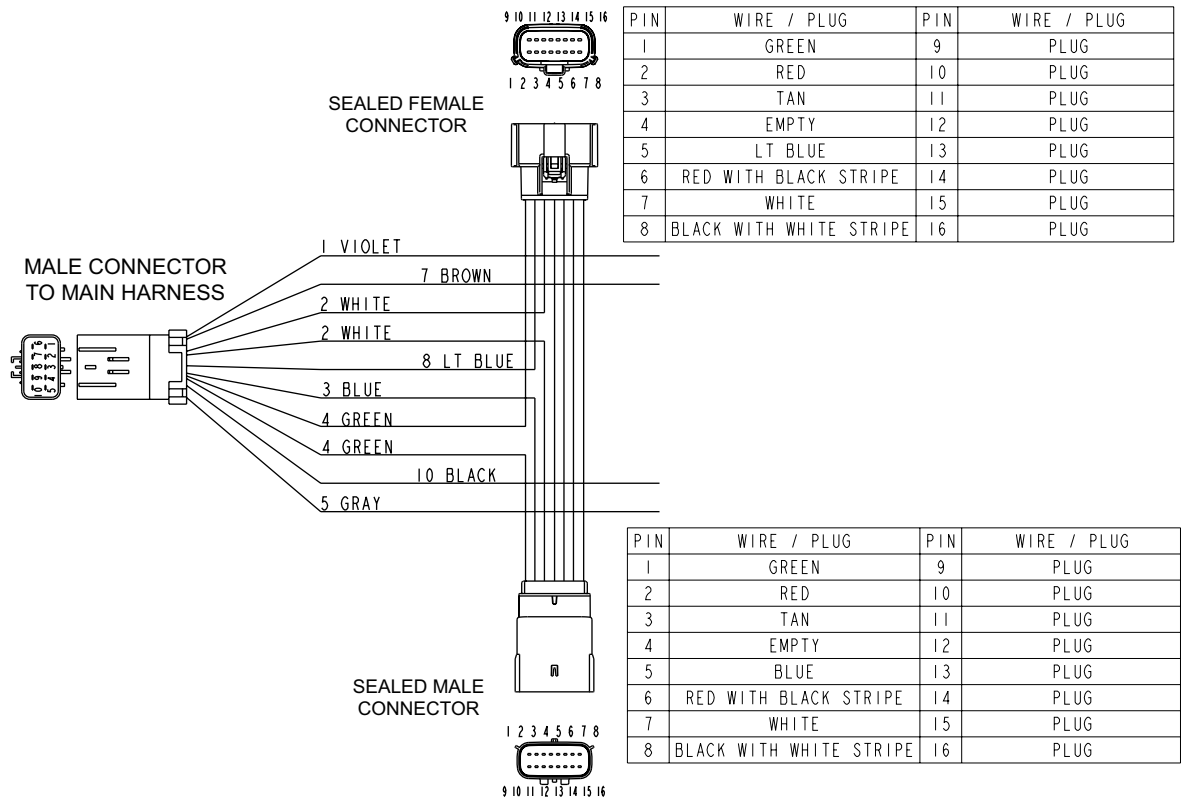

Main EIS Adapter Schematic (96116724)

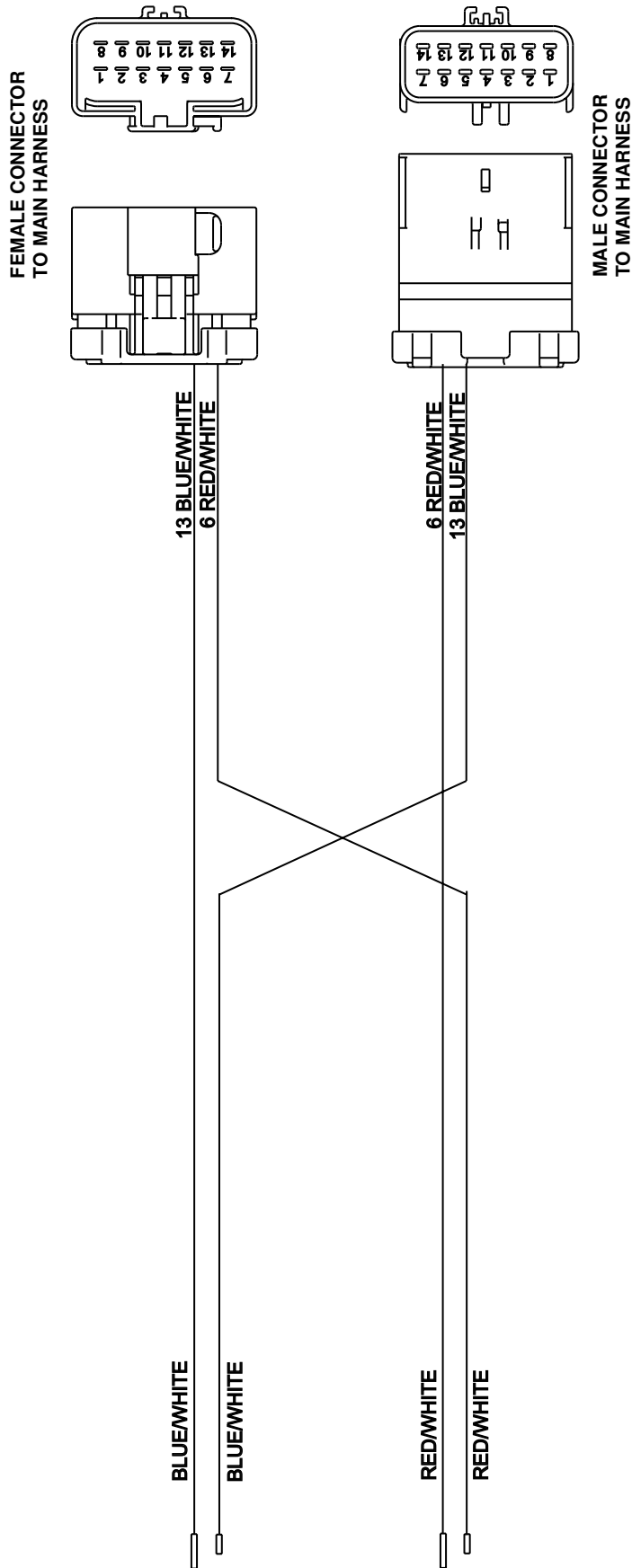

Plow Lamp Adapter Harness - (96116535) Driver & Passenger Side (2 Total, 1 per side)

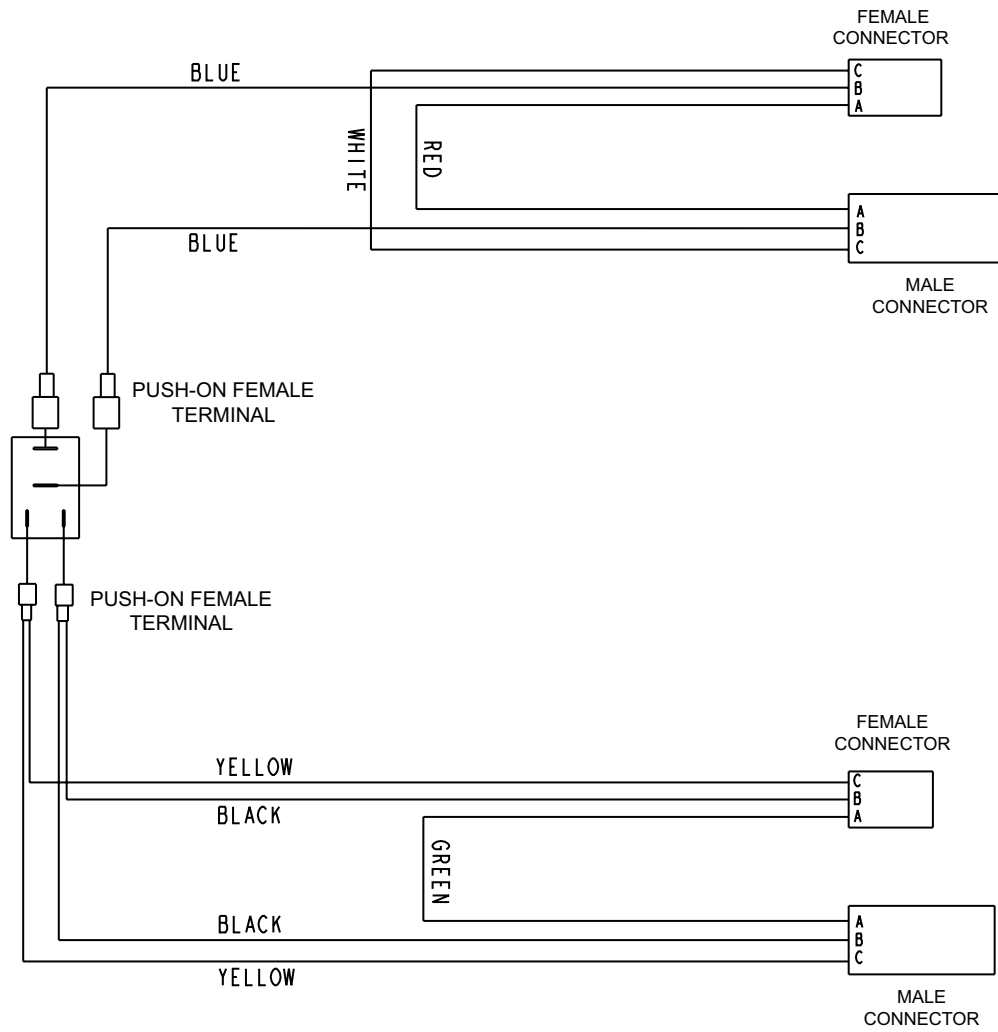

PRIOR TO INSTALLATION



CAUTION

- **THINK SAFETY, ALWAYS WEAR SAFETY GLASSES WHEN PERFORMING THE OPERATIONS PRESCRIBED IN THESE INSTRUCTIONS**
- **READ ALL INSTRUCTIONS CAREFULLY BEFORE ATTEMPTING INSTALLATION**

1. Locate the main EIS harness from the plow pack and Main EIS Adapter harness (96116724) from the adapter kit. Modification of the main EIS harness and plow lamp harnesses are needed to accept additional wires to function the plow and trucks lights properly. Additional wires are required because the vehicle has ground switching low beam lights, but power switching high beams.
2. Using needle nose pliers, pull out the Red secondary locks in the Black and Gray male connectors of both harnesses. (See Figure 1.)

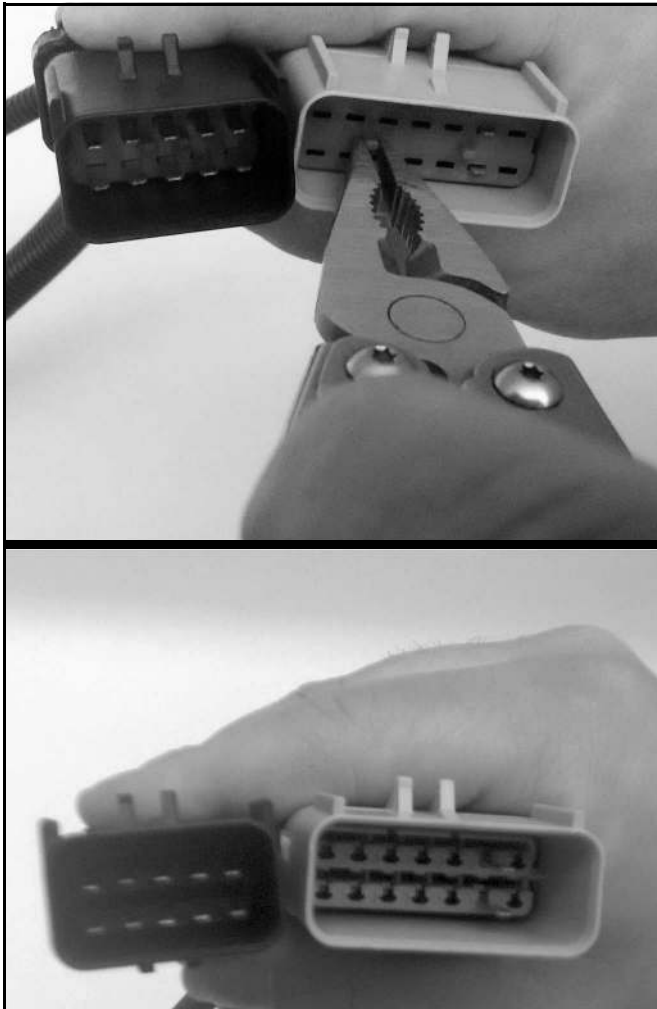

Figure 1

3. Pull the loom back from the Black connector so there is more room to work with the wires.
4. Relocate the wires from the Black connector to the Gray connector one-by-one, using a pick tool or anything with a thin/narrow tip: (See Figure 2.)

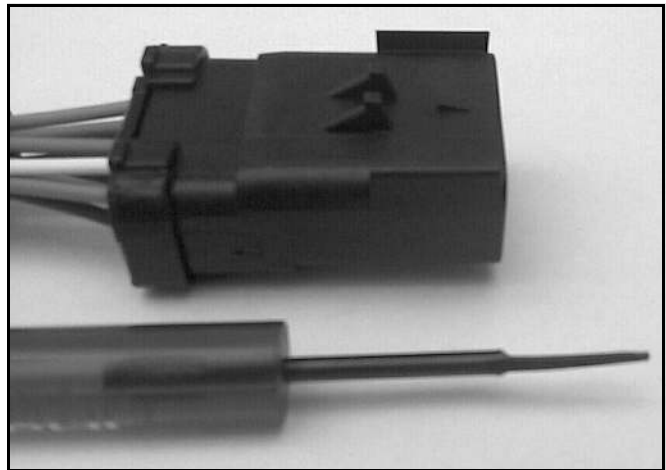

Figure 2

- Lift up the terminal lock in the Black connector for each terminal and pull the wire out, then place it into the Gray connector. (See Figure 3.)

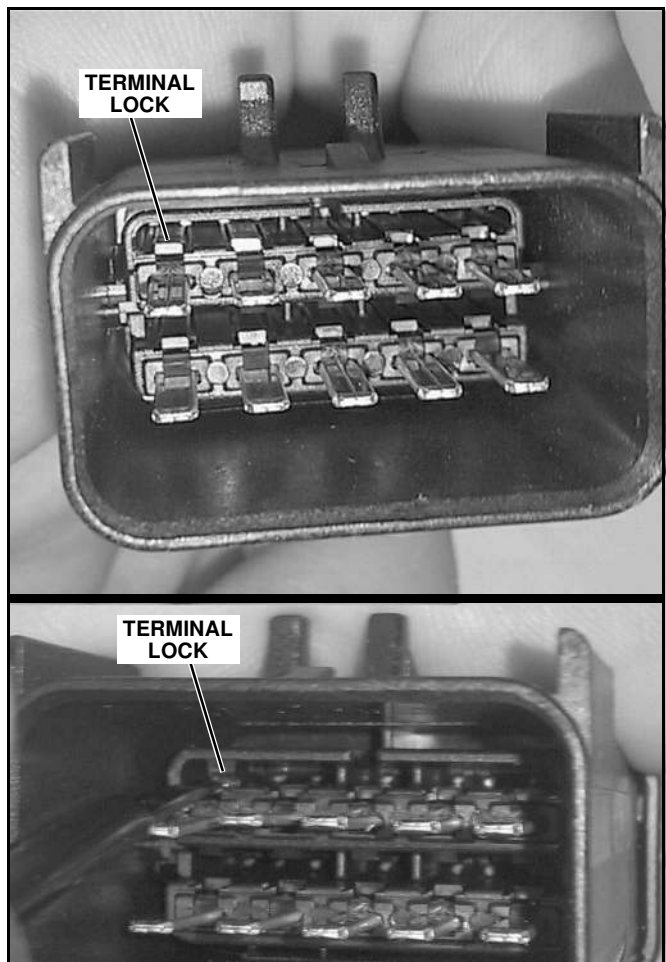

Figure 3

- Pins 1-5 from the Black connector go to pin cavities 1-5 of the Gray connector. Pins 6-10 from the Black connector go to pin cavities 8-12 of the Gray connector, etc. Pin cavity numbers are marked on the connector. (See Figure 4.)

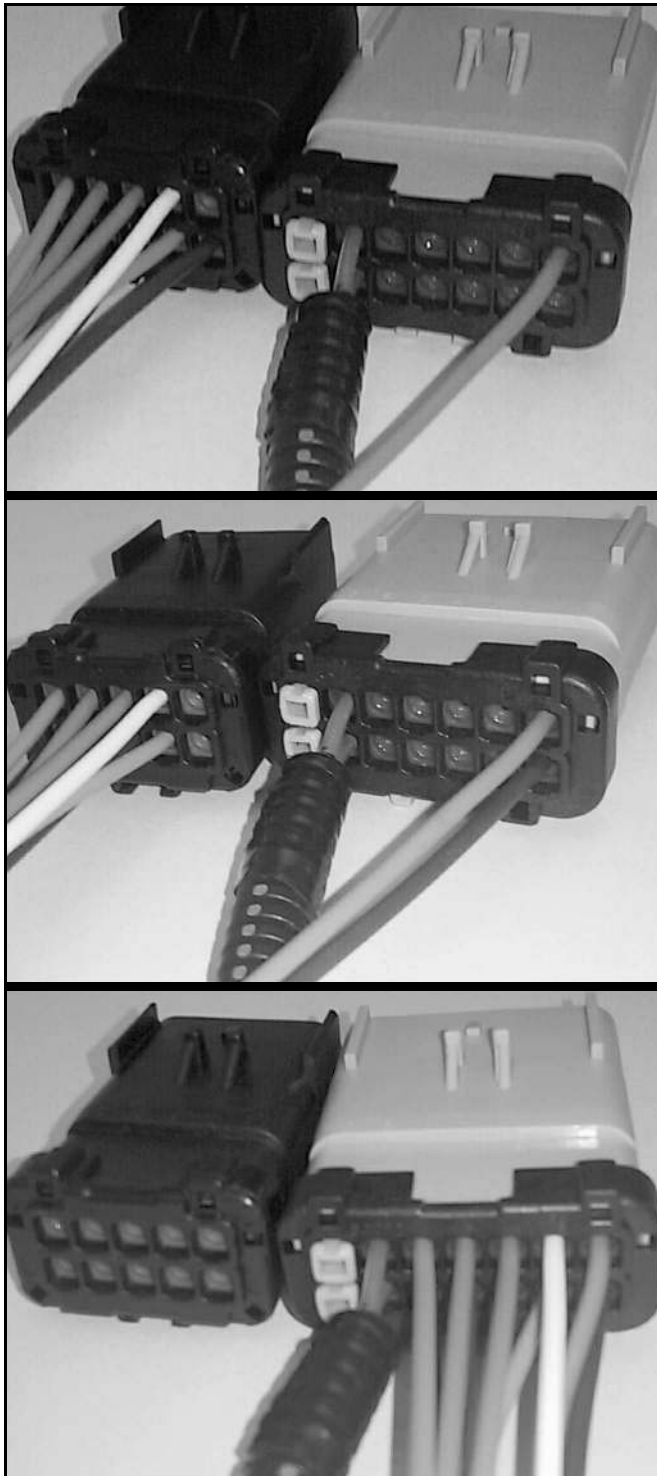

Figure 4

5. Review Figure 5 to make sure the wires are in the correct pin location. Then re-install the secondary lock for the Gray 14 pin connector and place the wires back inside the loom.

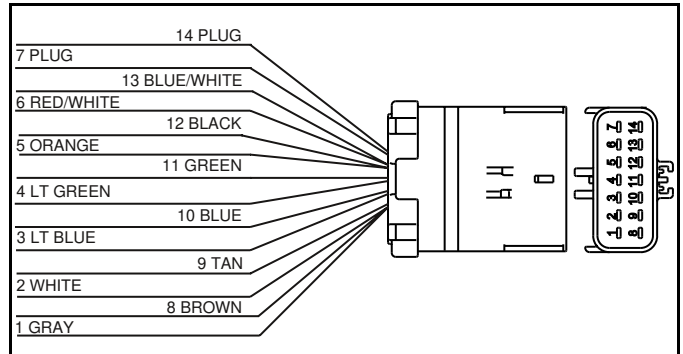

Figure 5

6. Using needle nose pliers, pull out the Blue secondary locks in the Black and Gray female connectors of both harnesses. (See Figure 6.)

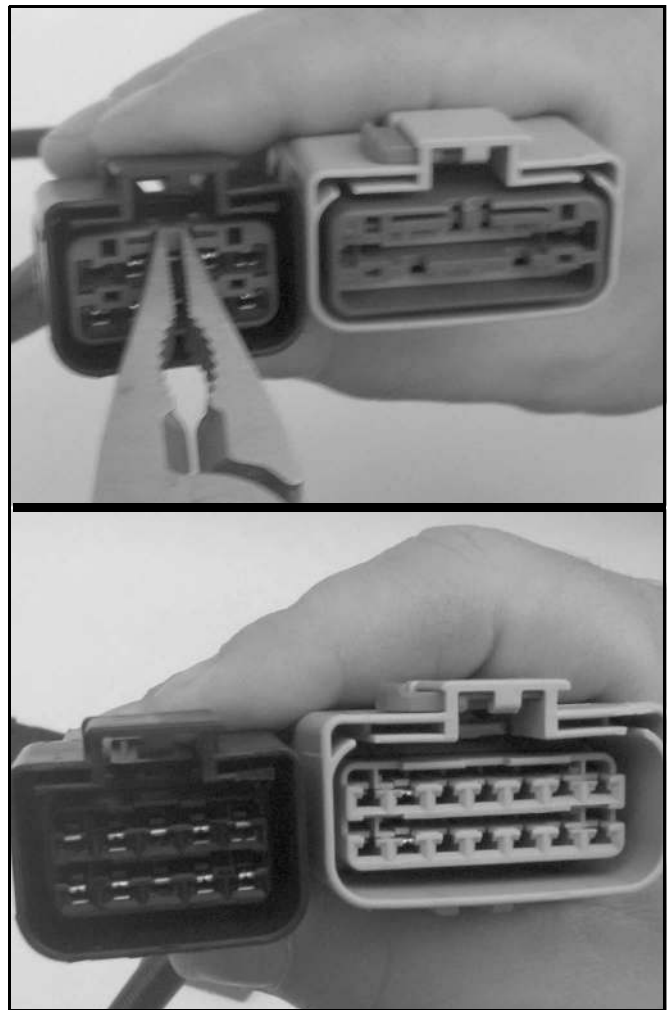

Figure 6

7. Repeat steps 3 & 4 for the Black female connector.

8. Review Figure 7 to make sure the wires are in the correct pin location. Then re-install the secondary lock for the Gray 14 pin connector and place the wires back inside the loom.

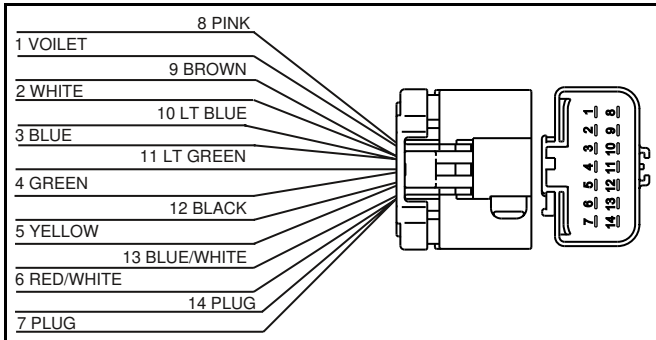

Figure 7

9. Layout the harnesses on top of one another and use the cable ties to hold the two looms together as one. (See Figure 8.) It does not matter which ends of the Main EIS Adapter (96116724) get tied to the ends of the EIS harness.

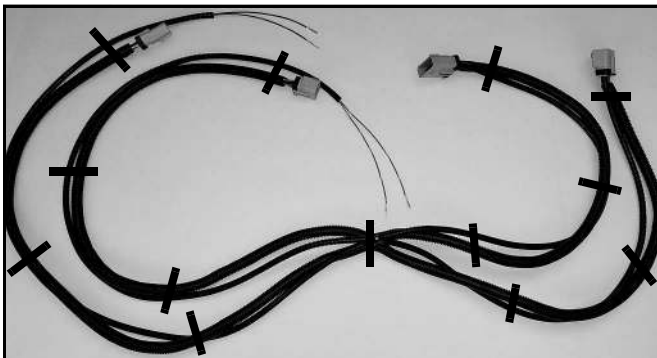

Figure 8

10. Locate the plow light harnesses, Male/Female Gray 14 pin connectors, and 10 cavity plugs. (See Figure 9.)

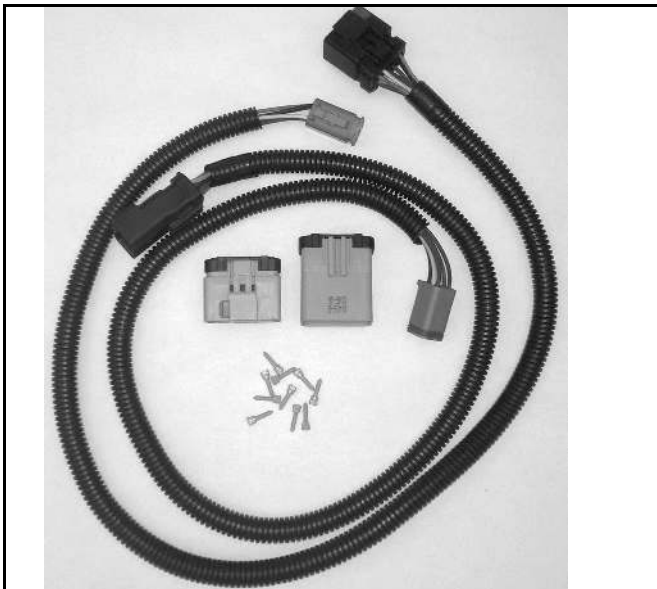

Figure 9

11. Put cavity plugs into Gray 14 pin connectors. For the male plug, locations 1, 6, 7, 13, 14. (See Figure 10.) For the female plug, locations 5, 6, 7, 13, 14. (See Figure 11.)



Figure 10 (Male Plug Locations)

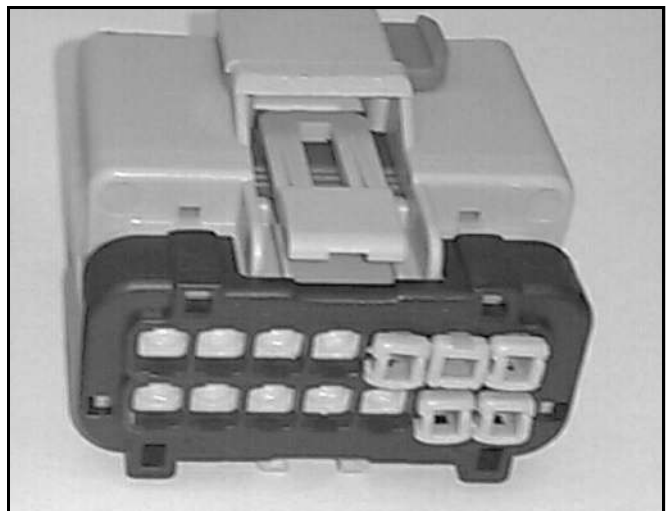

Figure 11 (Female Plug Locations)

12. Remove the secondary lock from the Black male connector as described in step 2.

13. Pull the loom back from the Black connector so there is more room to work with the wires.

14. Relocate the wires and plugs from the Black connector to the Gray connector as described in step 4, except cut and remove the Violet wire jumping from pin 7 to pin 1. (See Figure 12.)

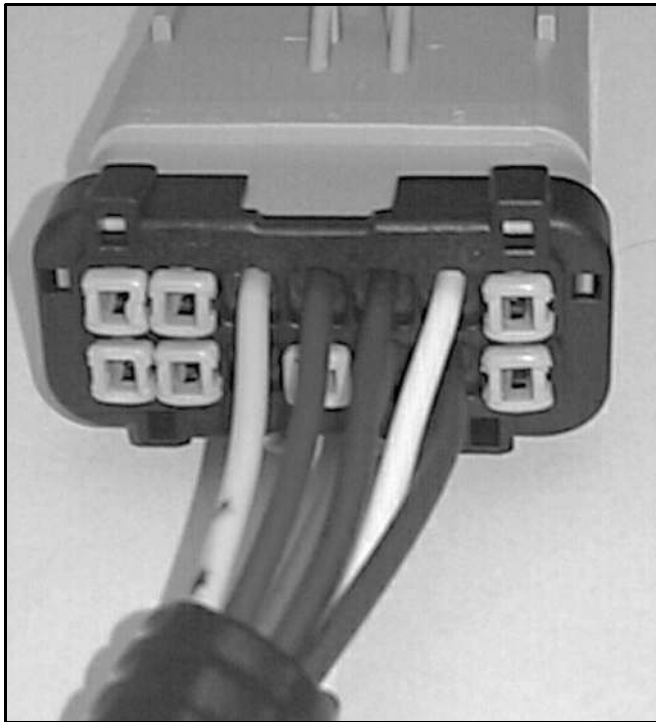

Figure 12

15. Review Figure 13 to make sure the wires are in the correct pin location. Then re-install the secondary lock for the Gray 14 pin connector and place the wires back inside the loom.

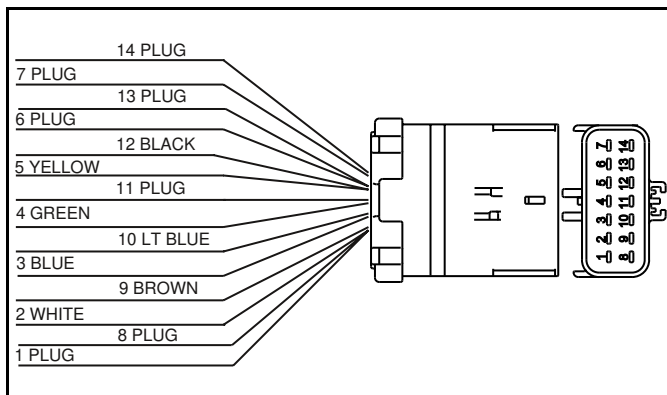

Figure 13

16. Remove the secondary lock from the Black female connector as described in step 6.
 17. Repeat steps 13 & 14 except for step 14, instead of the Violet wire, cut and remove the Orange wire jumping from pin 6 to pin 5. (See Figure 14.)

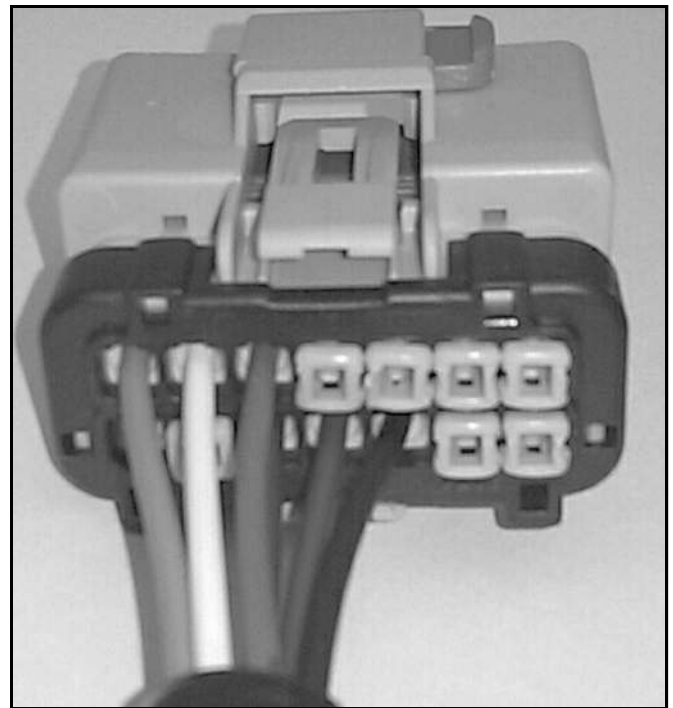

Figure 14

18. Review Figure 15 to make sure the wires are in the correct pin location. Then re-install the secondary lock for the Gray 14 pin connector and place the wires back inside the loom.

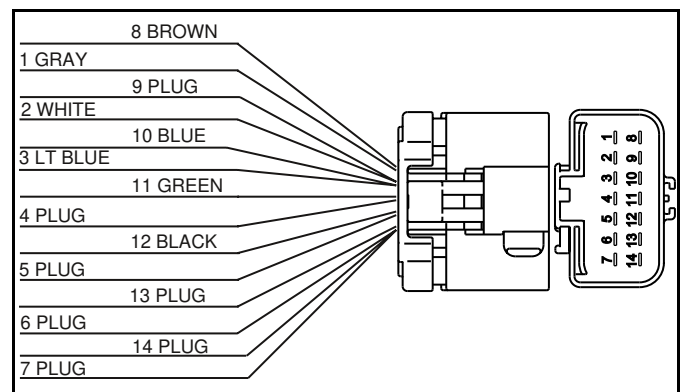

Figure 15

19. Locate the Gray 14 pin female connectors on the EIS harness and plow light harness. Pull out and remove the sliding red lock on top of the connectors. (See Figure 16.) Now the harnesses are ready for installation.

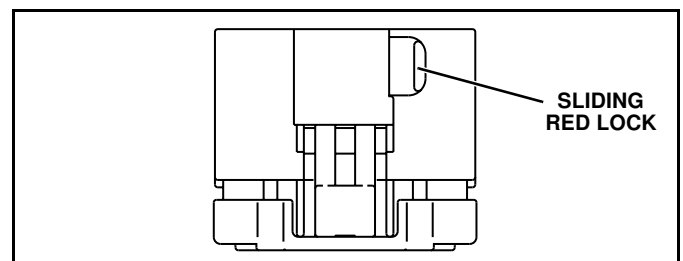

Figure 16

ADAPTER KIT INSTALLATION (Refer to Diagram)

IMPORTANT: Use a dielectric compound on all connections, including Scotch-Lock® connectors, to prevent corrosion.

1. Disconnect the vehicle headlight electrical connectors from the back of the vehicle headlamps.

NOTE: In order to disconnect some vehicle headlight connectors, it may be necessary to remove the headlamp assembly from the front of the vehicle, if the connector is not easily accessible.

2. Plug together the light green connectors on the main harness with the corresponding adapters needed for the vehicle. The driver's side connection has a yellow wire and the passenger side has a gray wire.

IMPORTANT: The correct adapters must be connected to each side for proper function.

3. Insert loose terminals into adapter connectors:
 - A. Use needle nose pliers to disengage the secondary lock inside the 16 pin connectors. The locks do not pull completely out; they only move in and out about 3/16 of an inch. (See Figure 17.)

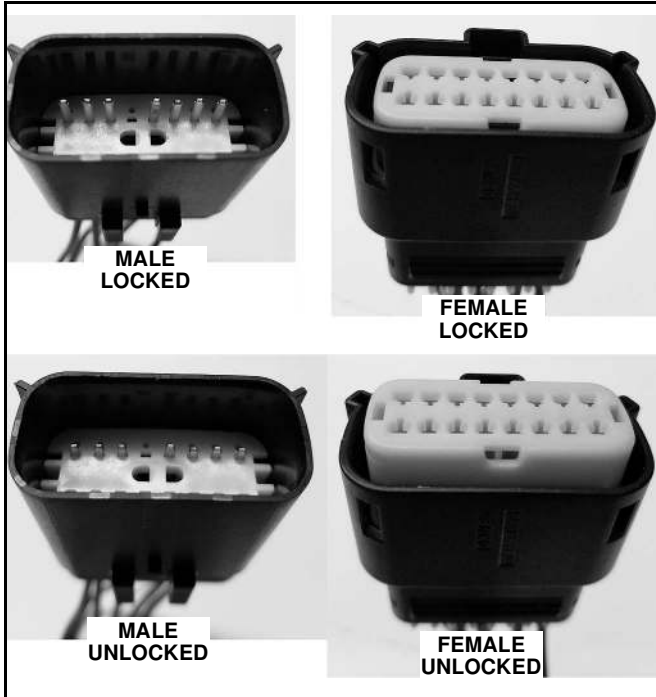

Figure 17

- B. Install the loose wires from the Main EIS Adapter harness (96116724) into the empty pin locations (pin 4) of the Headlight adapters. (See Figure 18.)

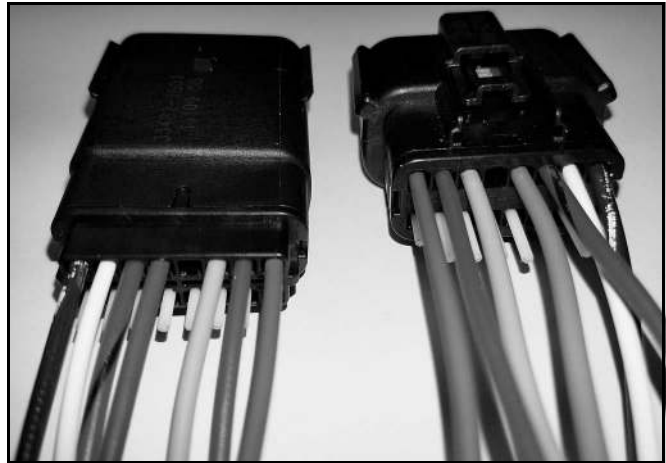

Figure 18

- C. Insert the two blue with white stripe wires into one headlight adapter. One wire has a male terminal and the other has a female terminal. Push them into back of the 16 pin connector; they can only enter one way. So make sure that bump in the terminals line up with the notch in the pin cavity. Push in the secondary lock when complete. (See Figure 19 and Figure 20.)

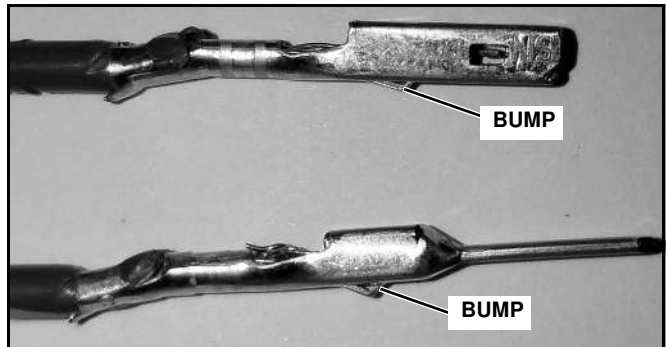

Figure 19

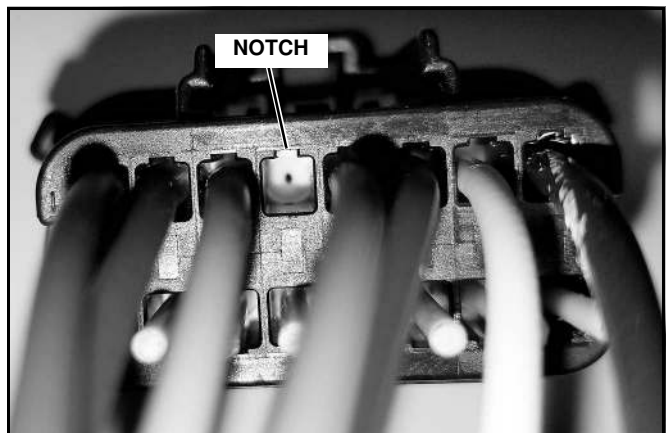

Figure 20

- D. Repeat step 3C for the two red with white stripe wires on the opposite side.

4. Plug the headlight adapters into the vehicle on both sides.
5. On the driver's side (Left Turn):
 - A. Locate the common wire to the left turn/park bulb on the vehicle harness. Using a Scotch-Lock® connector with dielectric compound, splice black headlight adapter wire to the vehicle's common wire.
 - B. Locate the left turn signal wire on the vehicle harness. At a suitable distance away from the turn signal connector, cut this wire. Using butt connectors, splice orange headlight adapter wire to the turn signal wire going to the turn signal lamp, and splice the yellow headlight adapter wire to the turn signal wire coming from the vehicle harness.
 - C. Locate the left park wire on the vehicle harness. Using a Scotch-Lock® connector with dielectric compound, splice the brown headlight adapter wire to the vehicle's park wire.
6. On the passenger side (Right Turn):
 - A. Locate the common wire to the right turn/park bulb on the vehicle harness. Using a Scotch-Lock® connector with dielectric compound, splice black headlight adapter wire to the vehicle's common wire.
 - B. Locate the right turn signal wire on the vehicle harness. At a suitable distance away from the turn signal connector, cut this wire. Using butt connectors, splice violet headlight adapter wire to the turn signal wire going to the turn signal lamp, and splice the gray headlight adapter wire to the turn signal wire coming from the vehicle harness.
 - C. Locate the right park wire on the vehicle harness. Using a Scotch-Lock® connector with dielectric compound, splice the brown headlight adapter wire to the vehicle's park wire coming from the vehicle harness.
7. Place the other end of the main harness on the outside of the grille.
8. Remove the back panel to the plow head lamps.
9. Disconnect the 3-pin connector leading to the high and low beam of the Driver Side plow lamp. Then, connect the ends of the Plow Lamp Adapter Harness with white/blue/red wires to the male and female connections.
10. Disconnect the 3-pin connector leading to the park and turn bulb of the Driver Side plow lamp. Then, connect the ends of the Plow Lamp Adapter Harness with yellow/black/green wires to the male and female connections.
11. Insert a cable tie through the adhesive mount and secure it around the Plow Lamp Adapter Harness. Then, peel away the wax paper, and stick it to the inside bottom of the plow lamp. This will keep the excess wires from rattling inside the lamp.
12. Repeat steps 8-11 for the Passenger Side plow lamp.
13. Secure the back panel of the plow head lamps.
14. Attach the main harness connectors to the right and left plow light headlamps. Turn on the vehicle lights and check operation. Check to make sure the vehicle headlights go out and plow headlights come on. Check park and turn signals.
15. If disassembled, reassemble vehicle components.
16. Secure the main harness to a safe location with electricians tape or plastic wire ties. Excess harness length should be neatly coiled and taped, or tied up out of the way.



CAUTION

Make sure that wire harness is routed away from all moving engine components. Example; fan, belts etc.
DO NOT attach wire harness to hoses, radiator AC coils, exhaust manifolds, or control cables.

SNO-WAY® INTERNATIONAL, INC.



Hartford, WI 53027 USA
Website: www.snoway.com
©2017 Sno-Way® International