

SNO-WAY®

SNOW & ICE CONTROL EQUIPMENT

WIRING DIAGRAM AND INSTALLATION INSTRUCTIONS

**FOR 99101152
ADAPTER KIT**

Sno-Way®, Down Pressure® and EIS® are registered trademarks of Sno-Way International, Inc.
ProControl™, MegaBlade™, V-Wing™, E-Z Switch™, Revolution™, MaxAdjust™, SpeedLock™, and QuickJack™
are trademarks of Sno-Way International, Inc.

©2014 Sno-Way® International

97101913A

WIRING DIAGRAM



1. THINK SAFETY, ALWAYS WEAR SAFETY GLASSES WHEN PERFORMING THE OPERATIONS PRESCRIBED IN THESE INSTRUCTIONS
2. READ ALL INSTRUCTIONS CAREFULLY BEFORE ATTEMPTING INSTALLATION

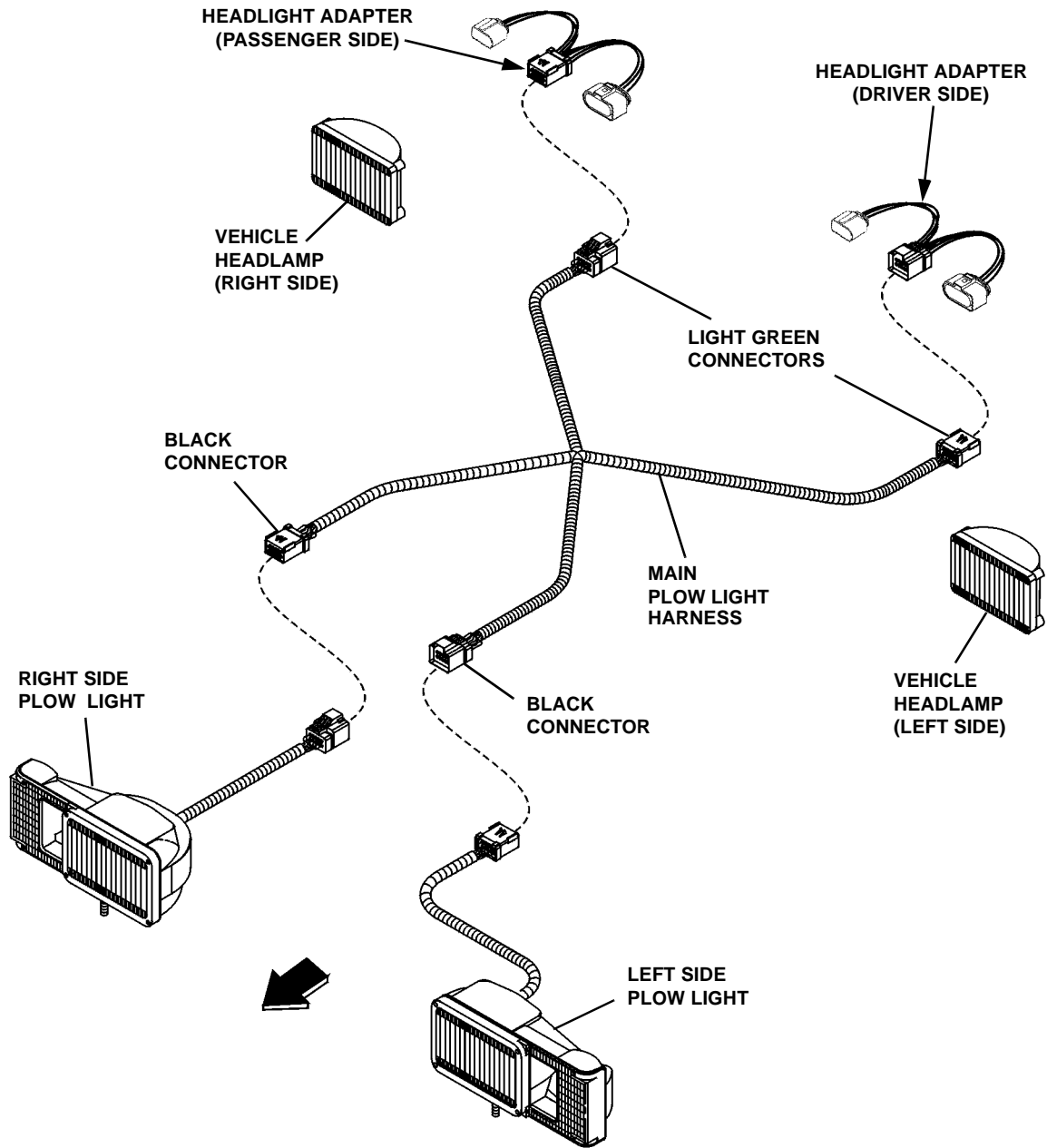
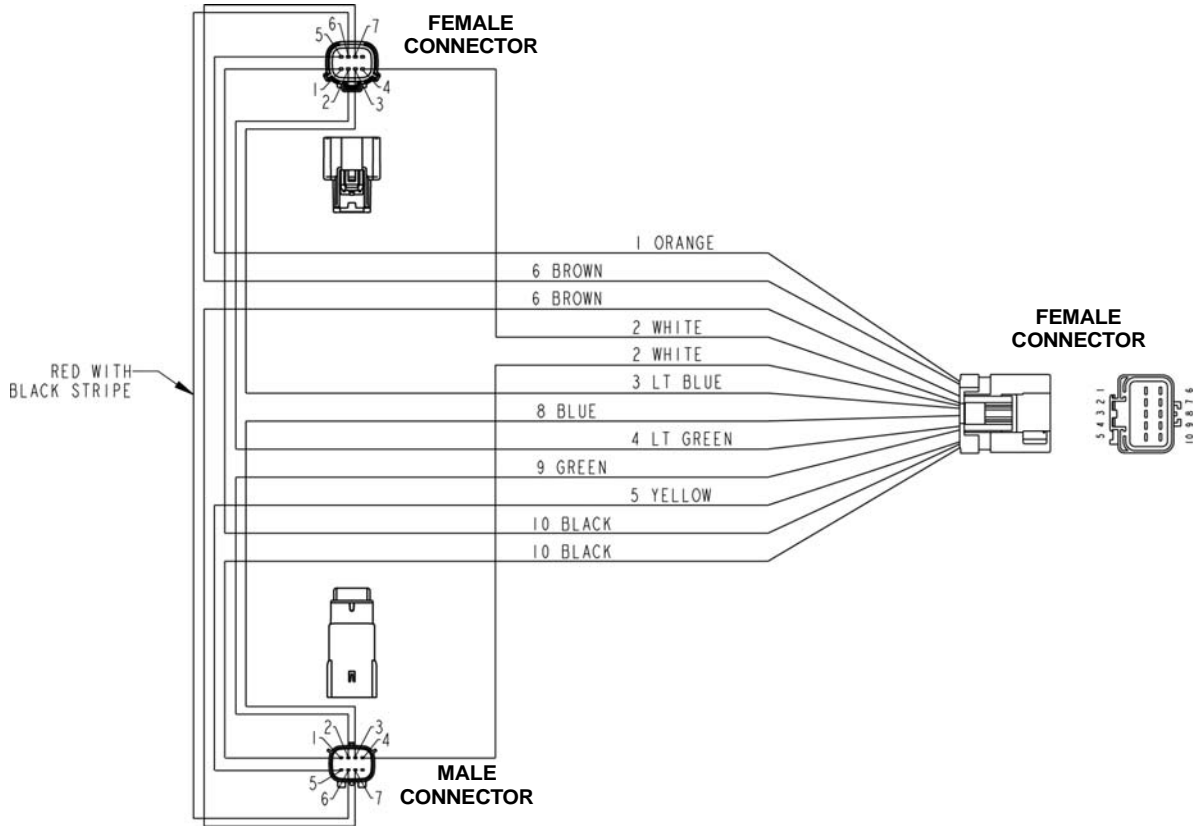

Figure 1

ADAPTER KIT 99101152

Headlight Adapter Schematic - Female (96115552) (Driver's Side)



Headlight Adapter Schematic - Male (96115553) (Passenger's Side)

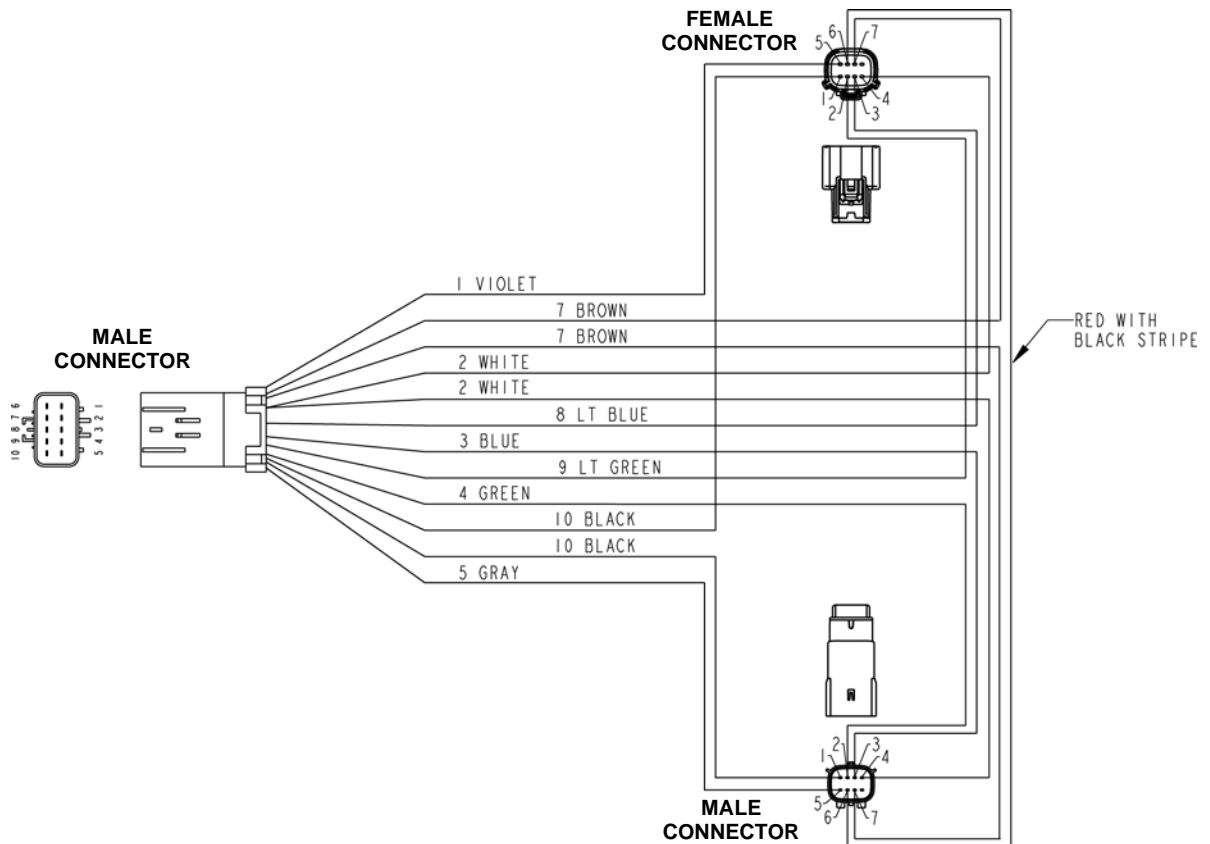

ADAPTER KIT INSTALLATION
(Refer to Wiring Diagram and Harness
Schematics for Kit Purchased)



CAUTION

- **THINK SAFETY, ALWAYS WEAR SAFETY GLASSES WHEN PERFORMING THE OPERATIONS PRESCRIBED IN THESE INSTRUCTIONS**
- **READ ALL INSTRUCTIONS CAREFULLY BEFORE ATTEMPTING INSTALLATION**

IMPORTANT: With vehicle and all lights and accessories off, apply a dielectric compound on all electrical connections to prevent corrosion.

1. Disconnect the Negative terminal from the battery or batteries.
2. Disconnect the vehicle headlight electrical connectors from the back of the vehicle headlamps.

NOTE: In order to disconnect some vehicle headlight connectors, it may be necessary to remove the headlamp assembly from the front of the vehicle, if the connector is not easily accessible.

3. Plug together the light green connectors on the main harness with the corresponding adapters needed for the vehicle. The driver's side connection has a yellow wire and the passenger side has a gray wire.

IMPORTANT: The correct adapters must be connected to each side for proper function.

4. Plug the headlight adapters into the vehicle on both sides. Plug the corresponding connectors into the back of the vehicle headlights, then the connectors from the vehicle headlights into the corresponding connectors on the headlight adapter.
5. Place the other end of the main harness on the outside of the grille.
6. Attach the Negative battery terminal removed in step 1.
7. Attach the main harness connectors to the right and left plow light headlamps. Turn on the vehicle lights and check operation. Check to make sure the vehicle headlights go out and plow headlights come on. Check park and turn signals.
8. If disassembled, reassemble vehicle components.
9. Secure the main harness to a safe location with electricians tape or plastic wire ties. Excess harness length should be neatly coiled and taped, or tied up out of the way.



CAUTION

Make sure that wire harness is routed away from all moving engine components.
Example; fan, belts etc.
DO NOT attach wire harness to hoses, radiator AC coils, exhaust manifolds, or control cables.

SNO-WAY® INTERNATIONAL, INC.

SNO-WAY
SNOW & ICE CONTROL EQUIPMENT

Hartford, WI 53027 USA
Website: www.snoway.com
©2014 Sno-Way® International