



**Adapter Kit
Wiring Diagram
&
Installation Instructions**

FOR 99100800 ADAPTER KIT

WIRING DIAGRAM



1. THINK SAFETY, ALWAYS WEAR SAFETY GLASSES WHEN PERFORMING THE OPERATIONS PRESCRIBED IN THESE INSTRUCTIONS
2. READ ALL INSTRUCTIONS CAREFULLY BEFORE ATTEMPTING INSTALLATION

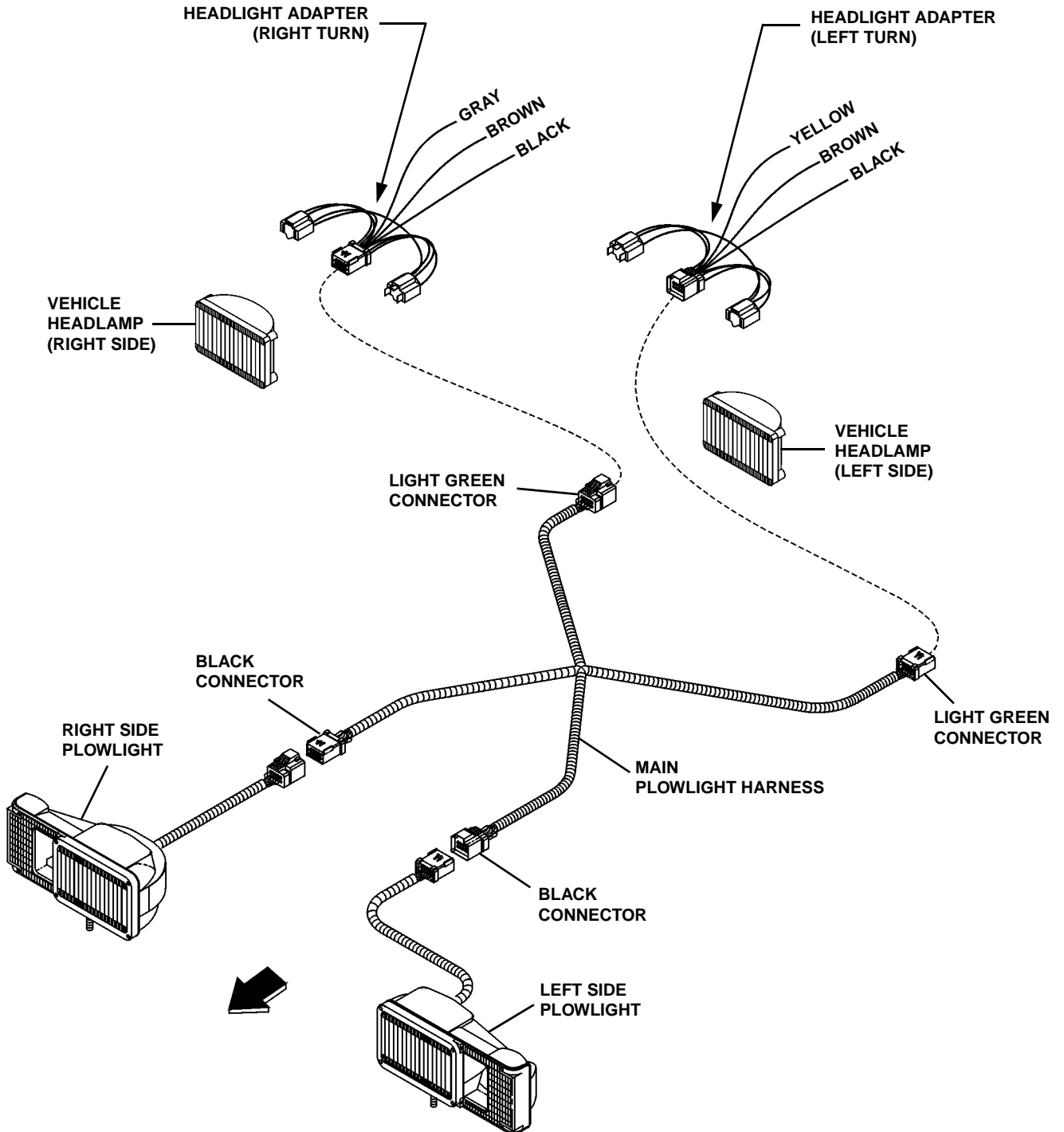

Headlight Adapter Schematic - Female (96107899)

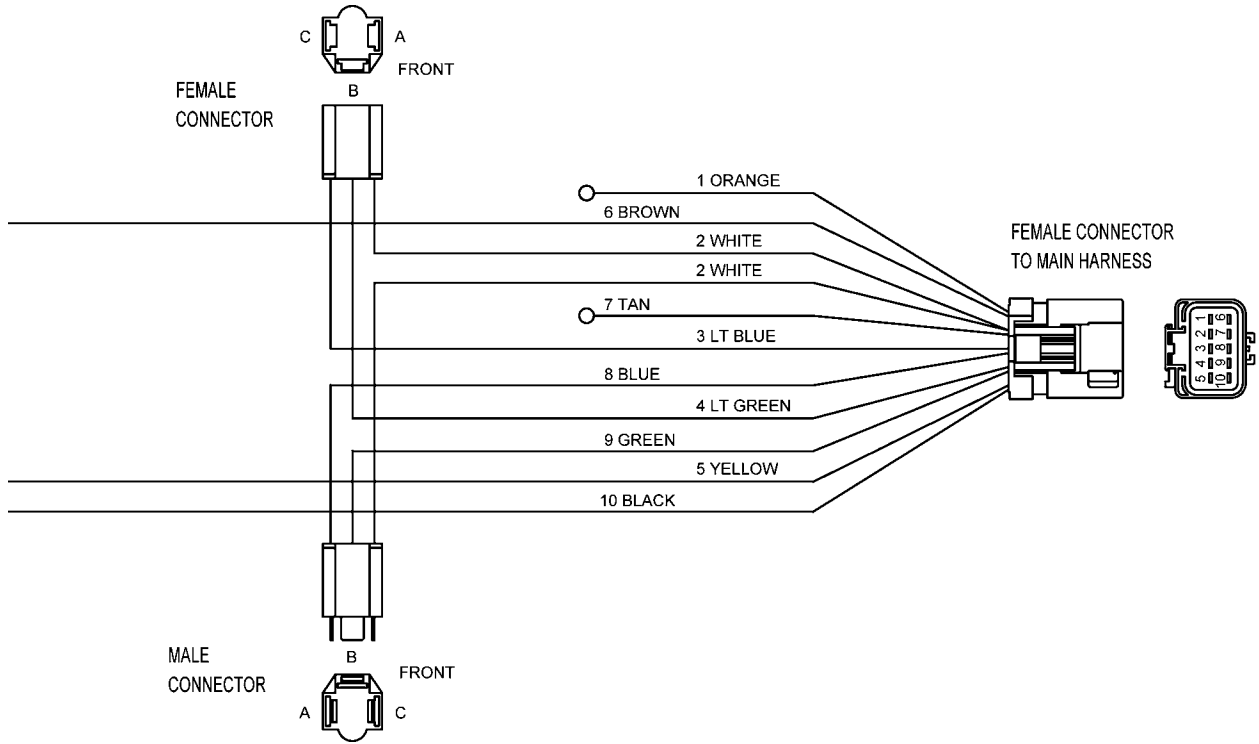

Headlight Adapter Schematic - Male (96107900)

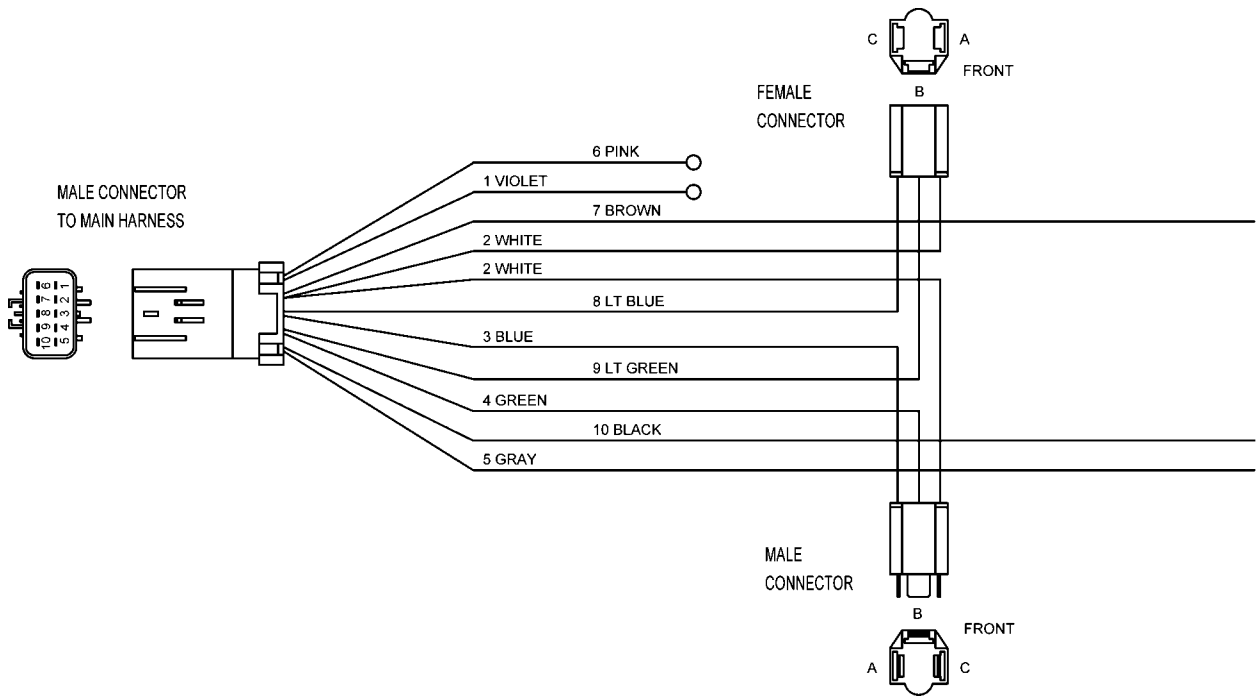

ADAPTER KIT INSTALLATION (Refer to Diagram)

CAUTION

- **THINK SAFETY, ALWAYS WEAR SAFETY GLASSES WHEN PERFORMING THE OPERATIONS PRESCRIBED IN THESE INSTRUCTIONS**
- **READ ALL INSTRUCTIONS CAREFULLY BEFORE ATTEMPTING INSTALLATION**

IMPORTANT: Use a dielectric compound on all connections to prevent corrosion.

1. Disconnect the vehicle headlight electrical connector from the back of the vehicle headlamps.

NOTE: In order to disconnect some vehicle headlight connectors, it may be necessary to remove the headlamp assembly from the front of the vehicle, if the connector is not easily accessible.

2. Plug together the light green connectors on the main harness with the corresponding adapters needed for the vehicle. The driver's side connection has a yellow wire and the passenger side has a gray wire.

IMPORTANT: The correct adapters must be connected to each side for proper function.

3. Plug the headlight adapters into the vehicle on both sides. Plug the corresponding connector into the back of the vehicle headlight, then the connector from the vehicle headlight into the corresponding connector on the headlight adapter.
4. On the driver's side (Left Turn):
 - A. Locate the left turn signal wire on the vehicle harness. Using a Scotch-Lock® connector, splice the yellow headlight adapter wire to the vehicle left turn signal wire.
 - B. Locate the left park wire on the vehicle harness. Using a Scotch-Lock® connector, splice the brown headlight adapter wire to the vehicle park wire.
 - C. Locate the left park/turn common wire on the vehicle harness. Using a Scotch-Lock® connector, splice the black headlight adapter wire to the vehicle park/turn common wire.
5. On the passenger side (Right Turn):
 - A. Locate the right turn signal wire on the vehicle harness. Using a Scotch-Lock® connector, splice the gray headlight adapter wire to the vehicle right turn

signal wire.

B. Locate the right park wire on the vehicle harness. Using a Scotch-Lock® connector, splice the brown headlight adapter wire to the vehicle park wire.

C. Locate the right park/turn common wire on the vehicle harness. Using a Scotch-Lock® connector, splice the black headlight adapter wire to the vehicle park/turn common wire.

6. Place the other end of the main harness on the outside of the grille.
7. Attach the main harness connectors to the right and left plow light headlamps. Turn on the vehicle lights and check operation. Check to make sure the vehicle headlights go out and plow headlights come on. Check park and turn signals.
8. If disassembled, reassemble vehicle components.
9. Secure the main harness to a safe location with electricians tape or plastic wire ties. Excess harness length should be neatly coiled and taped, or tied up out of the way.

CAUTION

Make sure that wire harness is routed away from all moving engine components.

Example; fan, belts etc.

DO NOT attach wire harness to hoses, radiator AC coils, exhaust manifolds, or control cables.

SNO-WAY® INTERNATIONAL, INC.

SNO-WAY
SNOW & ICE CONTROL EQUIPMENT

Hartford, WI 53027 USA
Website: www.snoway.com
©2007 Sno-Way® International