

Installation Instructions for Shoe Accessory 99100992

Item	Part #	Description	Qty
1	96102429	Shoe	2
2	96100095	Spacer	4
3	98009005	PW, 1, A Narrow	32
4	98009169	Pin, Lynch, 1/4" x 1 3/4"	2

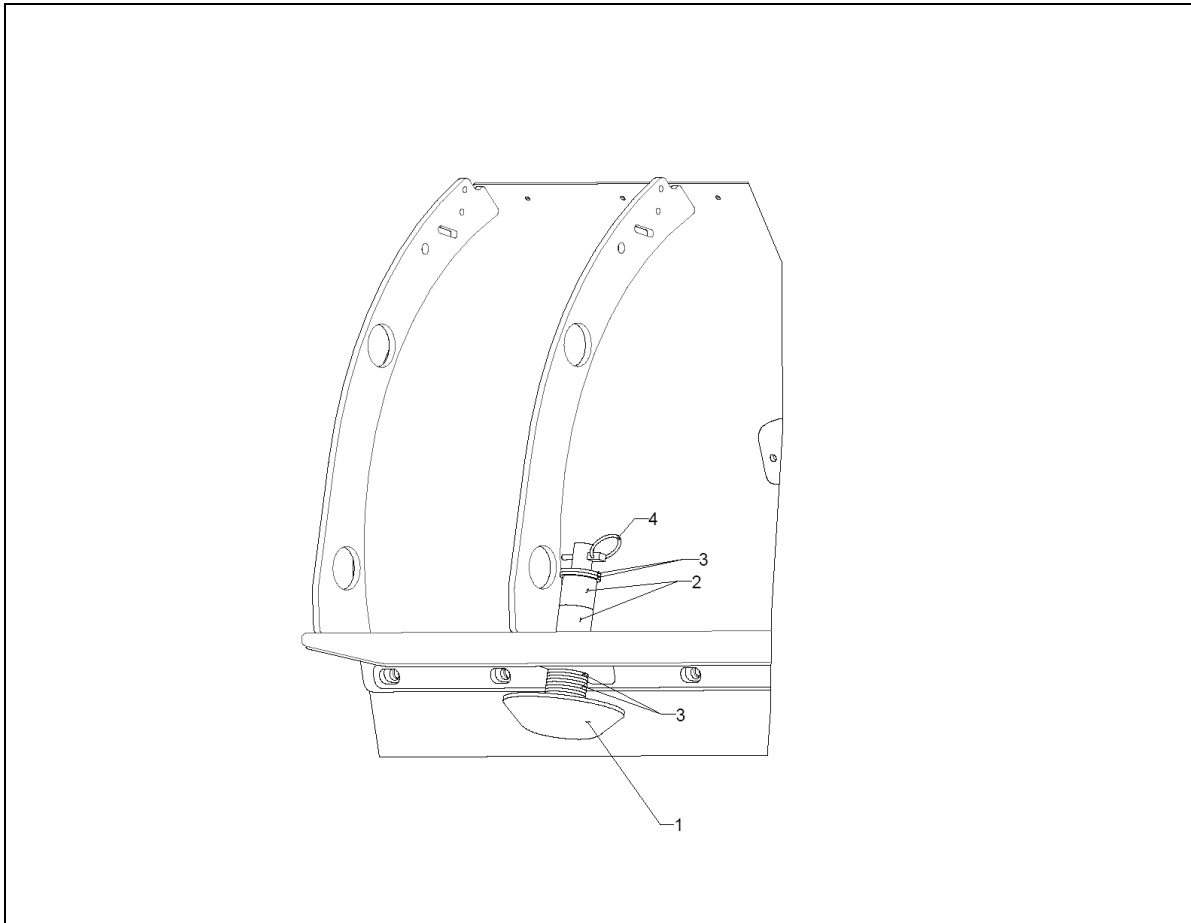

1. Adjust Shoe (#1) by removing the Lynch Pin (#4) and adding or subtracting Washers (#3) on the top or bottom of the bottom rail. (Shown in figure above. Note number of washers will very depending on where you locate your shoe.) Use the Spacers (#2) on the top side of the bottom rail to take up the space between the rail and the pin.

Important: Snap lynch pin ring over so that it locks around the shoe pin. If necessary rotate the lynch pin to lock around the shoe pin. If the lynch ring does not lock around the shoe pin it could fall out.